

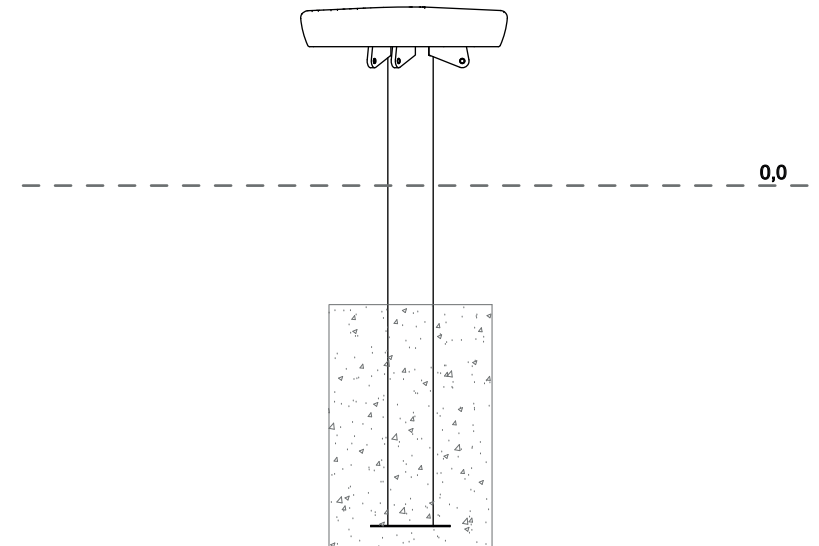









CC

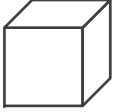

1	SW21118		1x Ø560 x 100	3.7kg
2	76701008		1x Ø375 x 1255	31.3kg
3	10290801		4x M8_A_Ø8.4 x Ø16 x 1.6_A2	0.002kg
4	10130830		4x M8x30_A2	0.02kg

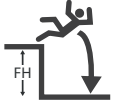
<p>S12</p>  <p>kg</p> <p>35.1</p>	<p>S15</p>  <p>L x W x H (m)</p> <p>Ø0.56 x 0.45</p>	<p>S13</p>  <p>m³</p> <p>0.1</p>	<p>S14</p>  <p>m²</p> <p>6.00 x 6.00</p>
<p>S6</p>  <p>EN1176</p> <p>0.45m</p>	<p>S20</p>  <p>2 x 1</p>	<p>S24</p>  <p>10121000 - TX45</p>	

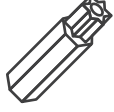
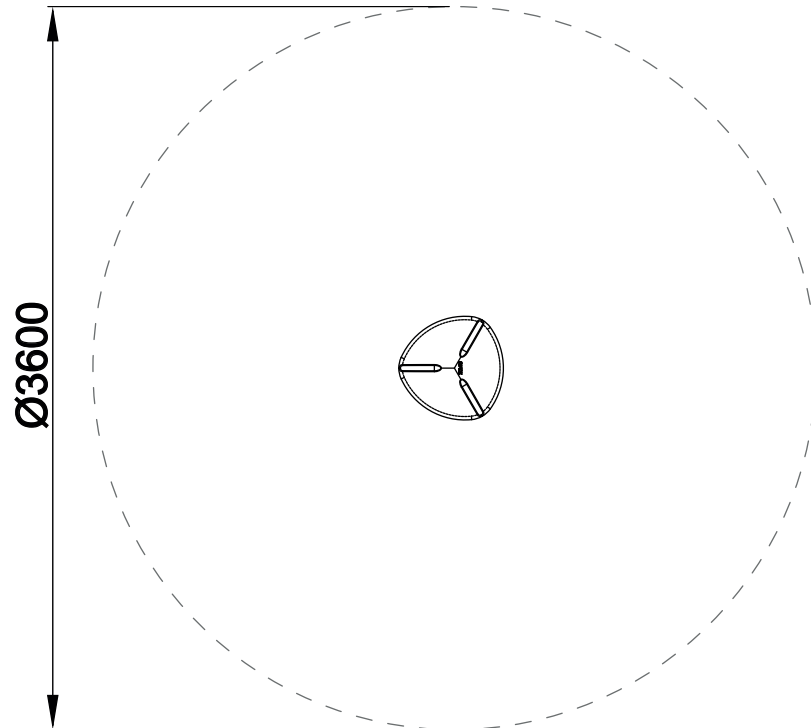

1

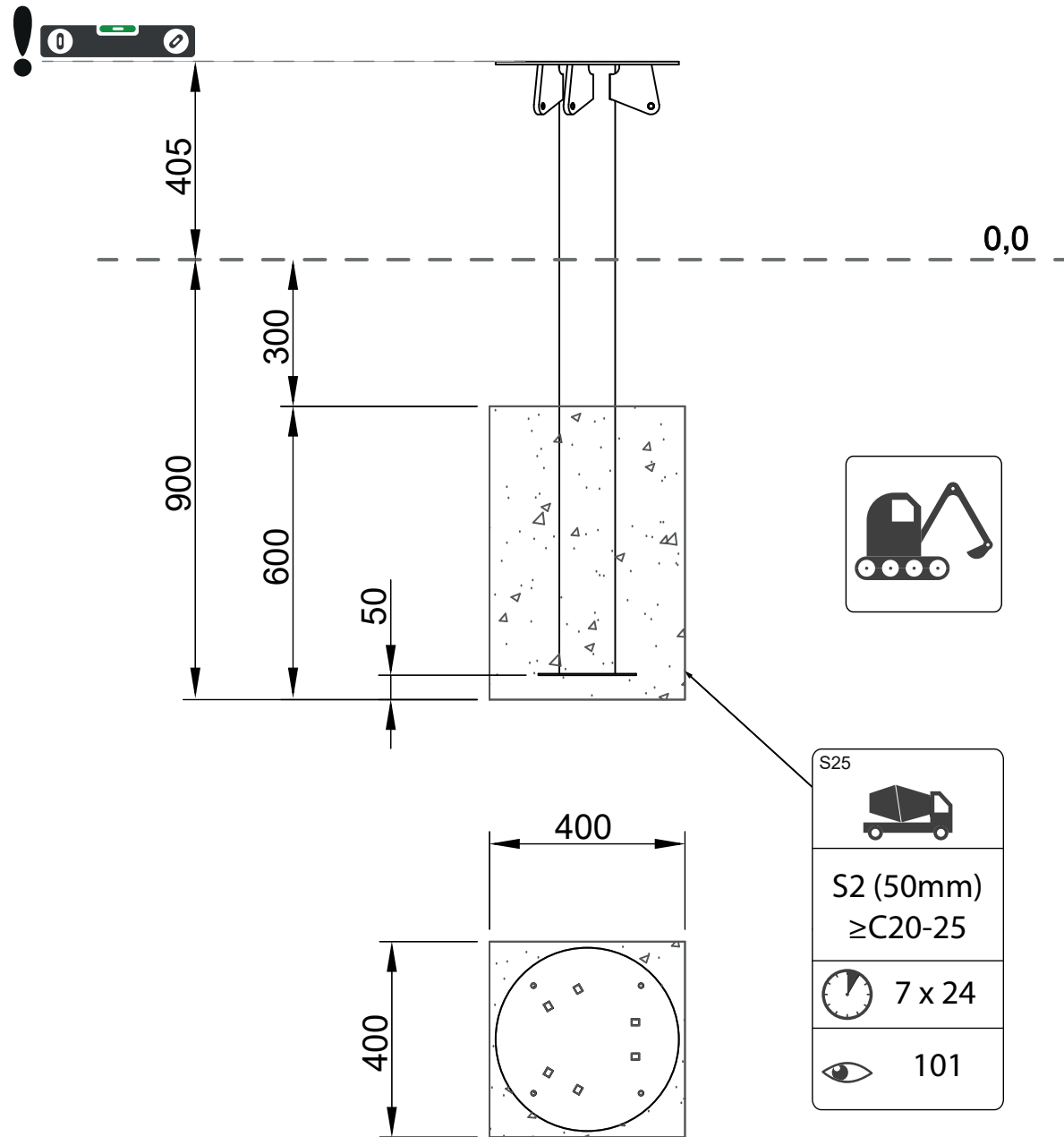

2

